

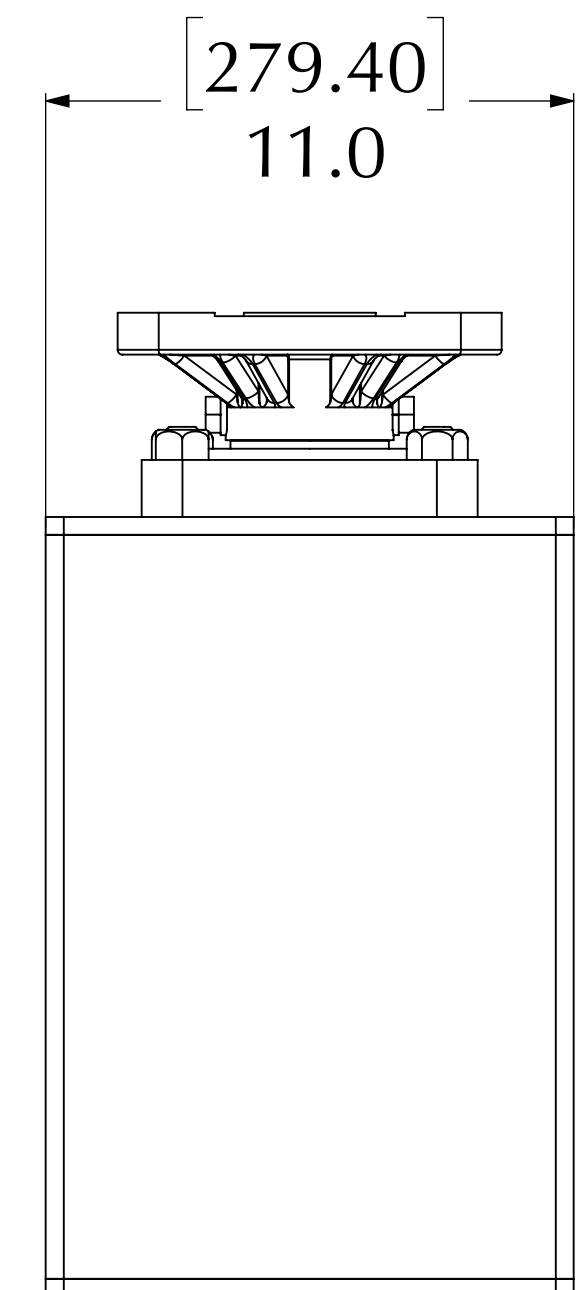

L-100

Part Number: 136001 341

Hanging Weight Capacity.....3120 lbs [1415 kg]
 Compressive Weight Capacity.....3120 lbs [1415 kg]
 Max Display Size.....Contact Dynapac
 Standard RPM.....4
 Torque Output @ 2 RPM.....350 ft-lbs [474.5 Nm]
 Motor Draw.....12A (1440 watts)
 Safety Clutch.....Standard Feature
 Collector Ring Capacity.....15A at 115 V
 Shipping Weight.....200 lbs [90.7 kg]

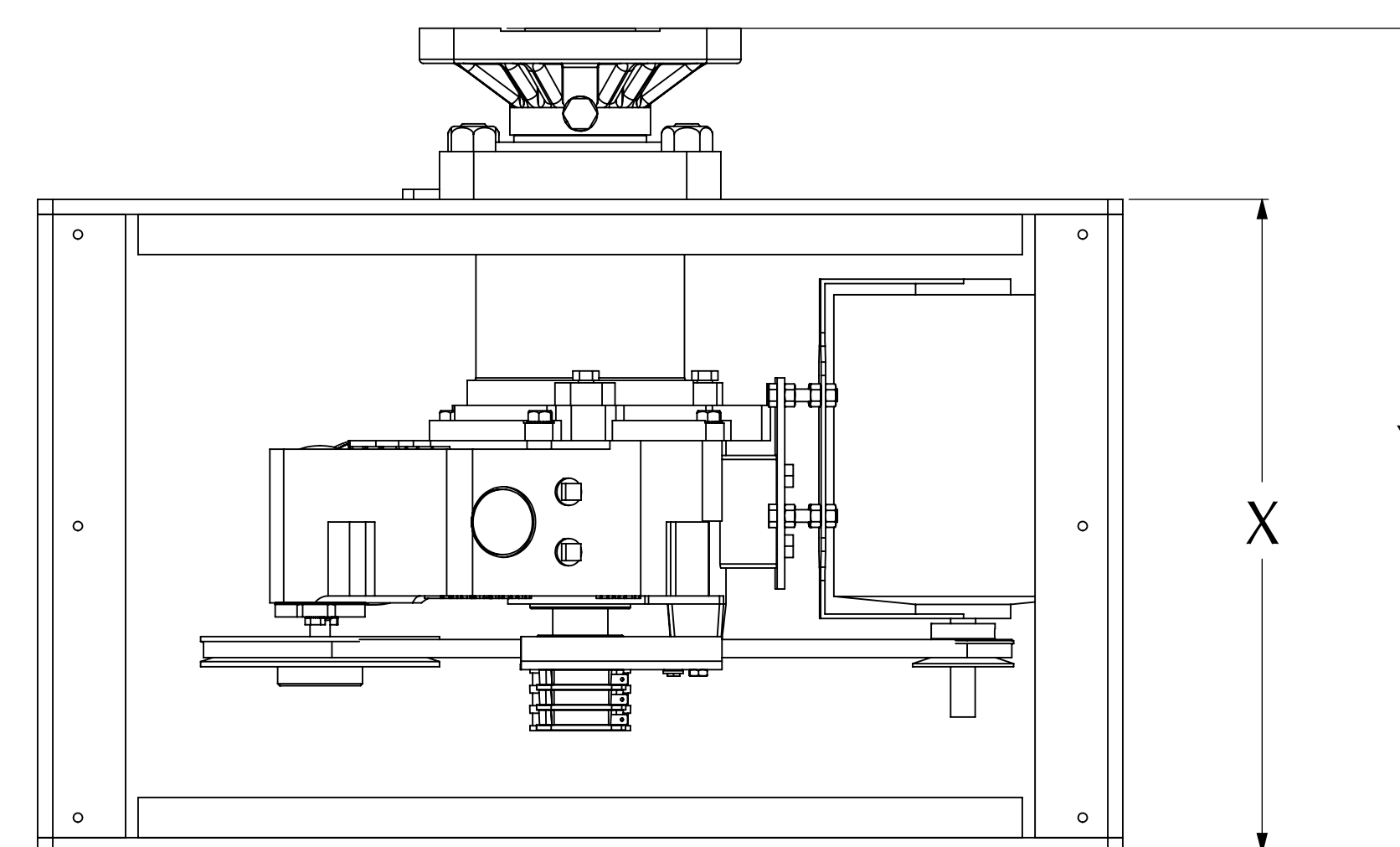
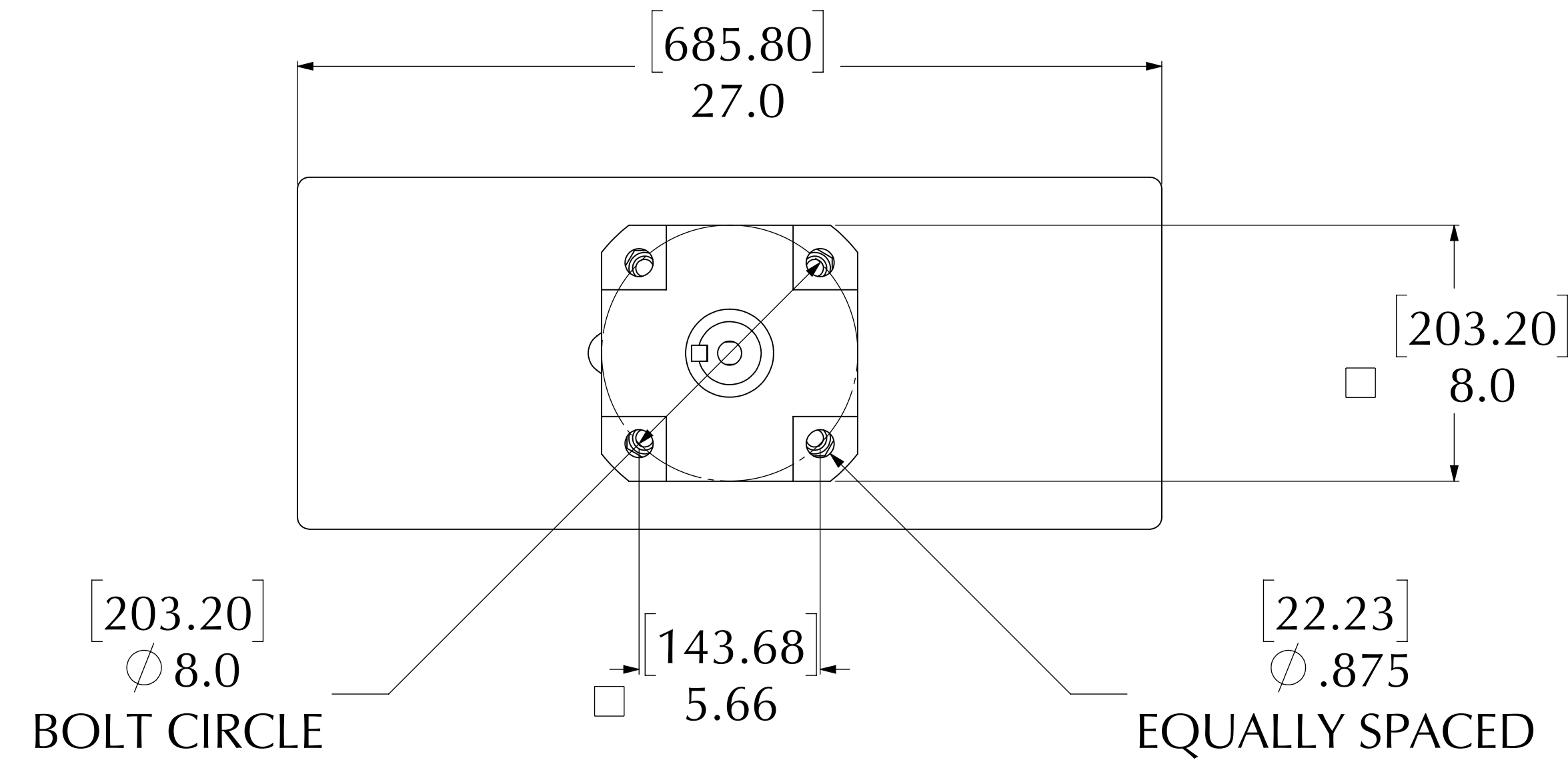
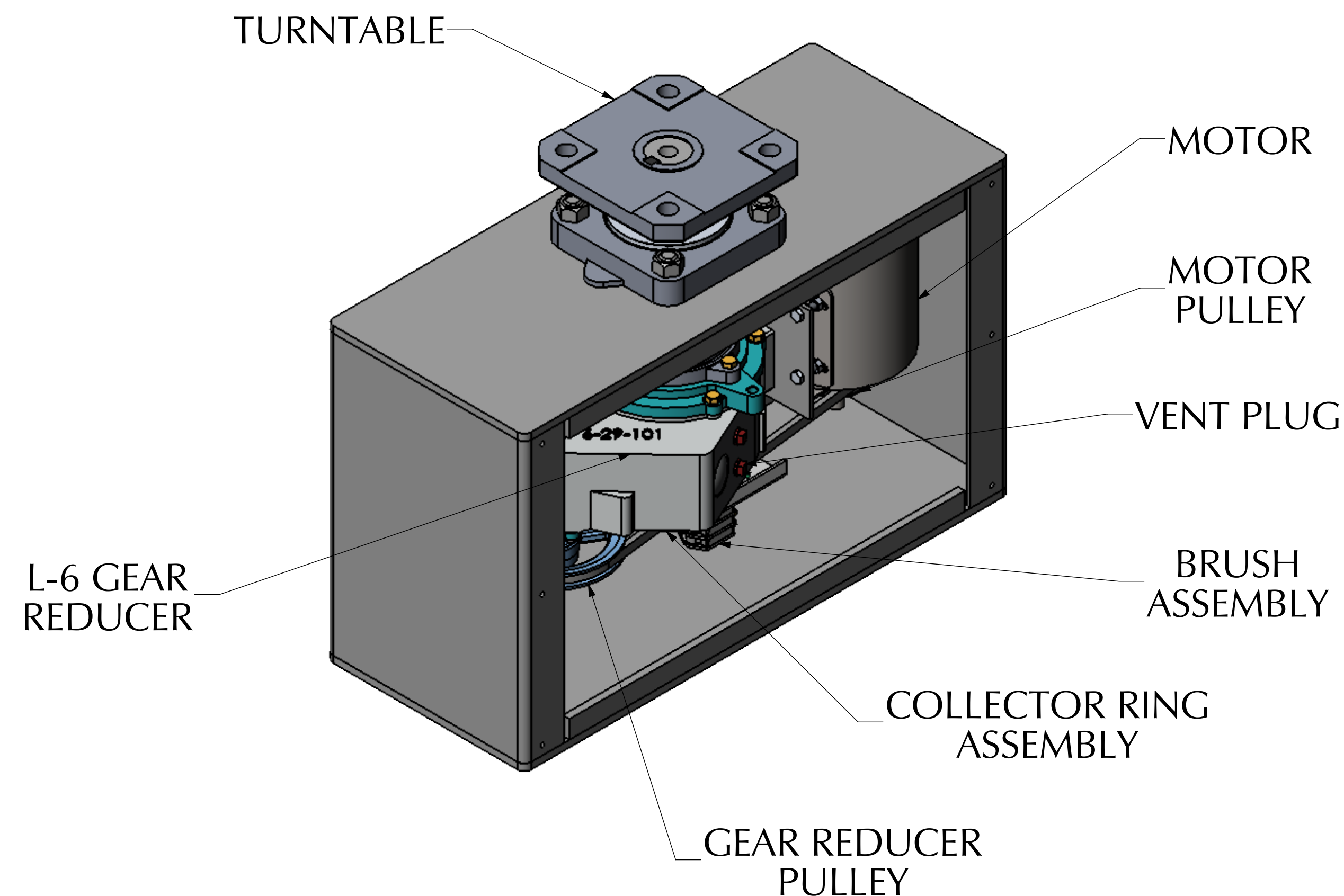

	X	Y
STANDARD FRAME	16.25" [412.75mm]	20.51" [520.85mm]
EXTENDED FRAME	22.25" [565.15mm]	26.51" [673.25mm]

NOTE: MAX COLLECTOR RINGS ON STANDARD UNIT IS 5.

Dynapac Rotating Company Inc.
 338 Hansen Ave., Salt Lake City, UT 84115
 Phone: 801-485-2221 • Fax: 801-485-2254
 email: info@dynapacrotating.com • www.dynapacrotating.com